

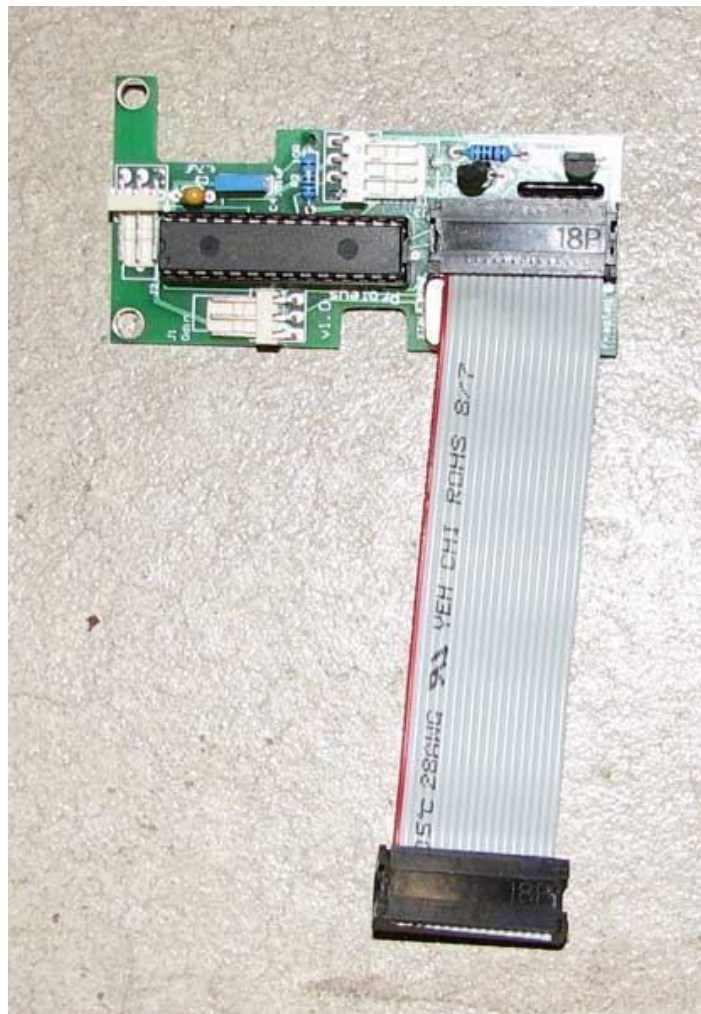

FragTag Proteus Users Manual

Version 2.75 FragTag 24-06-2008



FragTag Proteus User Manual

Copyright© 2005, 2006, 2007, 2008 FragTag

All rights reserved. No part of this work may be reproduced in any form or by any means – graphic, electronic, or mechanical, including photocopying, recording, taping, or information storage and retrieval systems – without the written permission of the publisher.

Products that are referred to in this document may be either trademarks and/or registered trademarks of the respective owners. The publisher and the author make no claim to these trademarks.

While every precaution has been taken in the preparation of this document, the publisher and the author assume no responsibility for errors or omissions, or for damages resulting from the use of information contained in this document or from the use of programs and source code that may accompany it. In no event shall the publisher and the author be liable for any loss of profit or any other commercial damage caused or alleged to have been caused directly or indirectly by this document.

June 2008 Melbourne, Australia.

TERMS

FragTag products are protected by both Australian Copyright Law and international copyright treaties. You may not separately publish, market, distribute, sell or sublicense, for fee or no fee, the Licensed Product or any part thereof.

FragTag will endeavour to provide free access to software updates to all purchased products that are still currently in development. The distribution method of these updates is at the sole discretion of FragTag, and for security reasons product updates may involve returning electronic components to FragTag or a licensed distributor. In this instance return postage costs may be payable by the purchaser.

WARRANTY

FragTag warrants that your purchased product will perform substantially in accordance with the provided documentation for a period of 12 months from the date of receipt. In the event of deviations in the product, FragTag will make a reasonable effort to bring the product into conformance with the documentation to provide you with a corrected version as soon as possible.

This warranty is void if the product failure has resulted from abuse, accident, or misapplication. FragTag's liability is limited to refund of the money paid for the product, and in no event will FragTag be liable for any indirect or consequential damages that may arise (including damages for loss of business profits, business information, or other pecuniary losses).

Table Of Contents

Copyright Notice	2
Table Of Contents	3
Introduction.....	5
Proteus Features	6
Transmission Protocol.....	6
Display	6
Sound	6
Fire Outputs.....	6
Sensors.....	6
Fire Modes.....	6
Data Logging.....	6
Special Features	6
Proteus Hardware Layout.....	7
Installation.....	7
Hardware Installation and Configuration.....	8
IC1 - Proteus Central Processing Unit (CPU).....	8
Sound Effects Controller (SFX) & BFS CPU Removal.....	9
Sound List	10
Mounting the Board.....	11
Over-Mount Method.....	12
Remote-Mount Method	14
J1 – Odin Communications Connector	15
Odin Master Controller Connections	15
J2 – Expansion Connector	16
Dallas Membership Button connections	16
J3 - FragTag Sensor Connector	18
Software Users Guide.....	19
Version Number	19
Configuration Data	19
Configuration Menus	20
Game Style	20
Health.....	21
Clips	21
Sound Set.....	21
Signal Format.....	22
Team	22
Player ID	23
Confirming Settings	23
Loading Default Configuration.....	23

Advanced Configuration Menus.....	24
Setting the BFS Casing Style.....	24
Setting the Sound Order	25
Setting the Weapon Types.....	26
Setting the Membership enable.....	27
Enabling Safety Fire Mode.....	27
PLAY MODE	28
Main Screen.....	28
Fire Modes.....	28
Reloading.....	29
Secondary Weapons.....	29
Taking Hits.....	30
The Hit LED	30
Dieing	30
Respawning	30
Screen Saver	31
ADVANCED TOPICS	32
Near Miss.....	32
Target	32
Timed Games and Remote Configuration	32
Membership Buttons	33
Stuns	33
Explosive and Radiation Damage	33
Anti-Cheat Functions.....	34
Power Logging.....	34
Sensor Failure	34
Field Code	34
Error Codes.....	35
Data Logging and Scoring	36
Upgrading the Firmware.....	39
Items Needed	39
Procedure.....	40
Troubleshooting.....	44

Introduction

Welcome to FragTag©, a highly advanced, dual format commercial 'laser' tag combat simulation system that follows open standards. The FragTag Proteus board is a hardware and software package to upgrade BFS equipment to a more advanced, full data-based system with enhanced features, convenience, cheat prevention, full scoring, remote configuration and superior maintainability.

Proteus Features

Transmission Protocol

- ❖ Dual transmission protocol support, user selectable at power-up.
- ❖ Supports WoW (World of Wonder) compatible equipment.
- ❖ Supports MilesTag 56K – full support for the ‘open’ protocol, MilesTag (based on the industry standard 56kHz carrier frequency).

Display

- ❖ Supports the standard 4 digit 7 segment LED display

Sound

- ❖ Programmable solid-state sound effects chip – based on the Winbond[®] ISD25xx series of Chipcorder[®] devices.

Fire Outputs

- ❖ Support for simulation of number of rounds per clip, number of clips, and reloading delays.
- ❖ Supports user selectable primary and secondary fire modes, e.g. secondary grenade launcher.
- ❖ Optional support (depending on Gun Build) for Alternating fire output. Either in a dual barrel type arrangement (alternating fire between them), or linked outputs together (in a single barrel) for very fast fire rates.

Sensors

- ❖ Supports BFS sensors, connected to standard sensor connector on BFS board
- ❖ Supports FragTag sensors, connected to J3 FragTag Sensor Connector

Fire Modes

- ❖ Fully selectable fire modes – full auto, burst fire or single shot.

Data Logging

- ❖ Full support for the FragTag Odin Master Controller for score uploading.

Special Features

- ❖ Self-hit prevention - Both WOW and Miles mode have self-hit prevention algorithms, to prevent hitting yourself via IR bounce.
- ❖ Sensor failure detection - If all of the sensors fail in the system (e.g. cable fault) or a cable is unplugged (cheating attempt), a loud alarm is heard and the system shuts down.

Installation

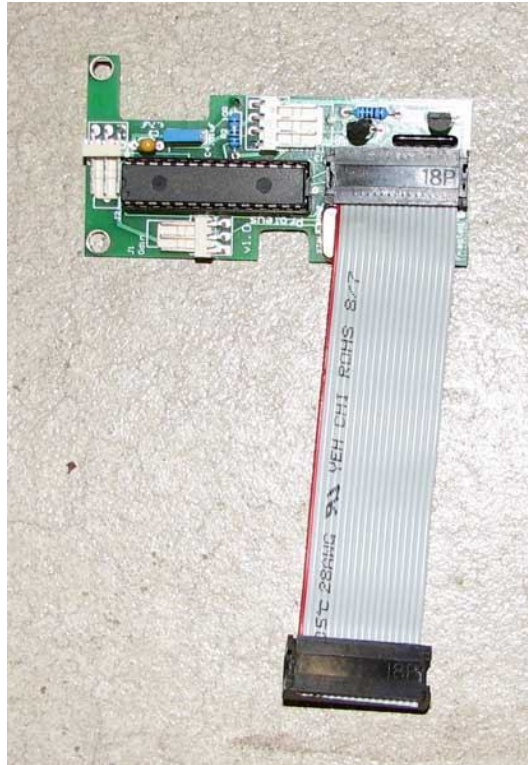

Figure 1. FragTag Proteus upgrade board

The Proteus expansion board is provided with 3 (M4) mounting holes. The kit package includes 2 plastic spacers and 2 plastic washers. These are provided to prevent the expansion board from shorting to any conductive surface inside the tag gun casing. Care must also be taken not to over tighten mounting screws to prevent damage to either the Proteus expansion board or the underlying (if the over-mount option is used) mainboard. Failure to follow these instructions will void the warranty.

Proteus is available in two types:

1. Normal Cable length. 100 mm long ribbon cable, suitable for the “over-mount method” and remote mounting where the board is close to the mainboard.
2. Extended Cable length. 200 mm long ribbon cable, suitable for remote mounting where the board cannot be placed close to the Mainboard.

Hardware Installation and Configuration

IC1 - Proteus Central Processing Unit (CPU)

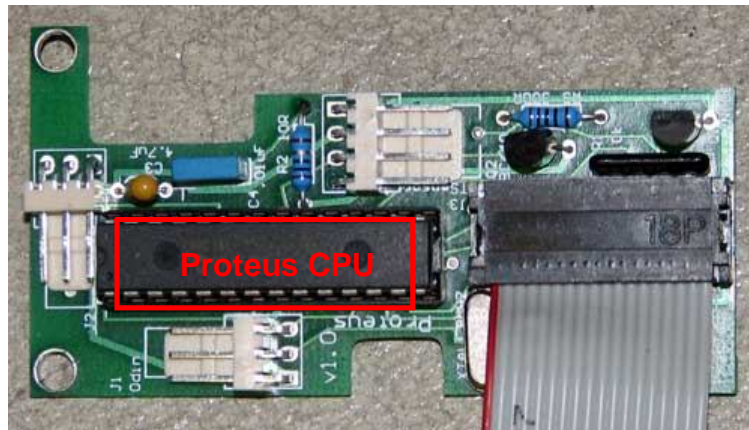

Figure 1. FragTag Proteus with CPU highlighted

The FragTag Proteus Expansion operates with a pre-programmed MicroChip® microcontroller (see Figure 1). The Proteus uses a 28-pin narrow IC socket for easy CPU installation/removal. Care must be exercised when inserting and removing the CPU so as to prevent damaging the IC pins. It is recommended the operator is sufficiently 'earthed' to prevent static electricity from damaging the CPU. An 'IC extraction tool' is also recommended for removing and inserting the CPU (refer Figure 2). Bent or otherwise damaged CPU pins are not covered under the limited warranty.

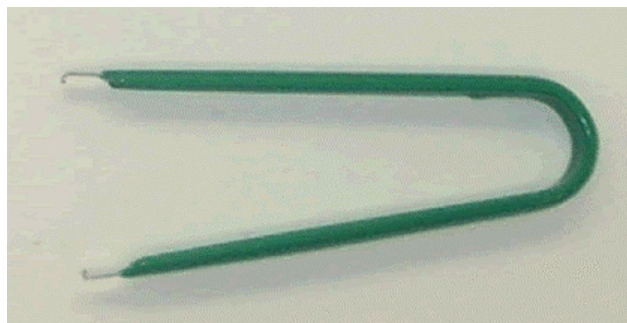

Figure 2. IC extraction tool.

Sound Effects Controller (SFX) & BFS CPU Removal



The FragTag Proteus upgrade is supplied with a pre-programmed WinBond® ChipCorder ISD2560 for storing all the required sound effects. This replaces the existing chip on the BFS board, and contains extra sounds to suit the advanced functionality of the system. Prior to installing the Proteus expansion board, both the existing SFX chip and CPU on the BFS board will need to be removed. The SFX chip will be replaced with the FragTag SFX chip and the Proteus connection lead plugs into the vacated CPU socket.

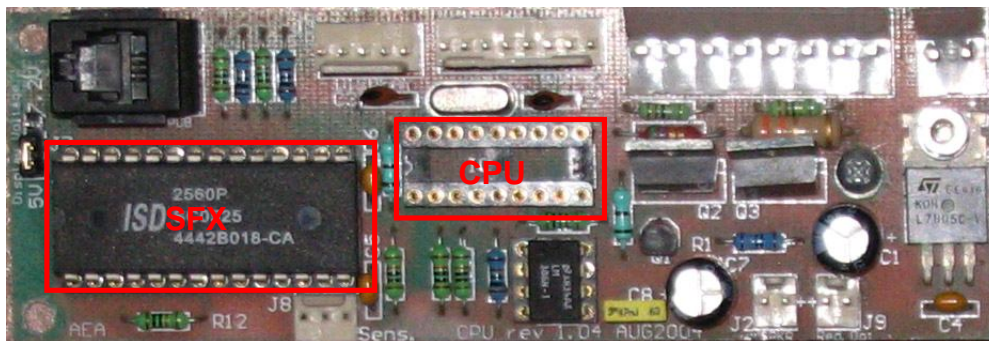

Figure 3. BFS board with CPU and SFX chip highlighted (CPU is removed in the picture)

The SFX chip located on the existing BFS board (refer Figure 3) must be carefully removed and replaced with the new SFX chip provided. Care must be exercised when inserting and removing the SFX Controller and CPU so as to prevent damaging the IC pins. It is recommended the operator is sufficiently 'earthed' to prevent static electricity from damaging the SFX Controller. We recommend the use of an 'IC extraction tool' for removing and inserting the SFX Controller (refer Figure 2).

Sound List

The SFX controller does come pre-recorded with a set of quality sound effects, however, the following information is provided for those who may wish to customize their sound effects. The system uses a list of pre-recorded sound effects for various system events, such as gunfire, when a player is 'hit' or their 'health' reaches zero etc. A specific order of sound effects is required for the proper function of the SFX. Each sound event can be of varying length, but the total recorded time (i.e. All sound events) must not exceed the chip's capacity of 60 seconds. All sound event slots must be filled even if the function is disabled (i.e. secondary fire slot and all primary fire mode slots must be filled) to preserve the list numbers of sound events. The sound list is as follows:

List #	Sound Event Label	Notes
1	Primary Fire A ¹	Main weapon fire sound effect
2	Primary Fire B ¹	Suppressed mode main weapon fire sound effect
3	Secondary Fire A ¹	Secondary weapon fire sound effect
4	Secondary Fire B ¹	Suppressed mode secondary weapon fire sound effect
5	Weapon Special	Special sound that can change depending on the weapon type used. Usually set to a "Target Hit" sound that is played when the system is configured as a Target and takes a hit.
6	Clip Empty	When all rounds in the clip have expired
7	Primary Reload	Reloading a primary clip sound
8	Secondary Reload	Loading a secondary round (e.g. grenade load)
9	Reload Complete	Indication sound to denote reload is complete
10	Hit	You have been 'hit' by another player
11	Explosive	Played when hit by explosive damage
12	Near Miss	Partial data detection, indicates incoming fire but not a hit
13	Alarm	Sensor failure alarm (anti-cheat feature)
14	Dead	Health has reached zero sound
15	Re-spawn	Indicates that a player has just been bought back to life by a Master Controller device
16	Heal	Player has been healed by a Medic device
17	Ammo Add	Player has been given additional ammunition by an ammo device
18	Low Ammo	Indicates that the ammunition in your current clip is almost empty (this sound is currently not played but may be used in the future)
19	Game Start	Indicates that a new game has just started
20	Game Stop	Indicates that the current game has just ended
21	Welcome	Played to welcome the player after a Membership button has been used.
22	Boot up	Sound played at power up to denote system is ready for play

Notes: ¹ – Fire mode A or B is selectable at boot-up (See software section, boot-up menus).

For some hints and tips on recording your own sound effects on the ISD25xx series chips please refer to our website (http://www.fragtag.com.au/ISD_recorder.htm).

Mounting the Board

There are 2 methods of mounting the Proteus Expansion Board. The first option is the direct 'over-mount' method where the Proteus sits directly on top of the existing BFS board. The second option is the 'remote-mount' method where the Proteus is mounted elsewhere in the tag gun casing and takes advantage of the 150mm long connecting lead (mounted already on the Proteus) to connect to the BFS board. Either option is equally suitable and is left to the installer's discretion as to what method is found easier to install. Each mounting method is detailed below. Please note the SFX chip must be replaced with the provided FragTag sound chip before the Proteus expansion board is fitted.

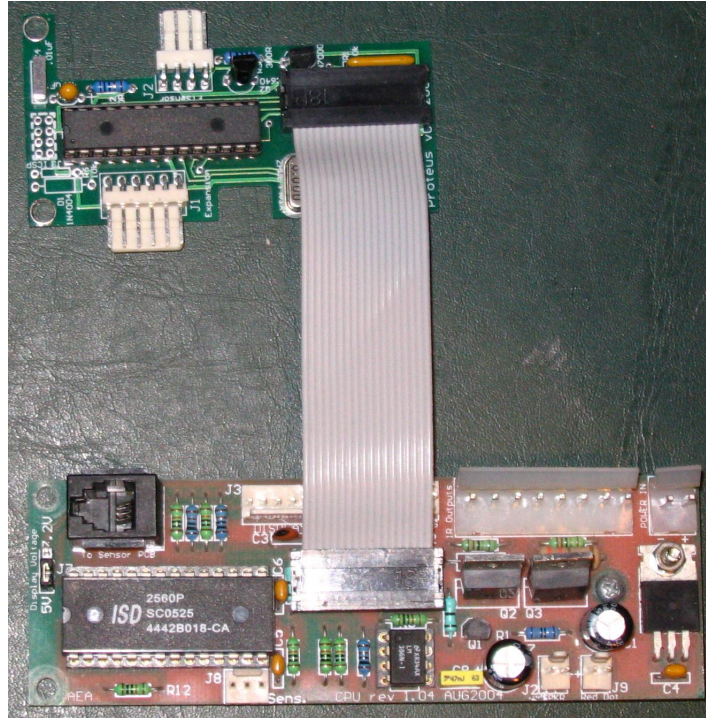

Figure 4. Proteus plugged into BFS board

First connect the Proteus connecting lead to the BFS board. The polarity of the connection is very important, the lead is designed such that the connector lead extends upwards when connected to the BFS board (refer Figure 4). Care must be exercised when inserting the connector so as to prevent damaging the connector pins. It is recommended the operator is sufficiently 'earthed' to prevent static electricity from damaging the Proteus expansion board and the existing BFS board.

Over-Mount Method

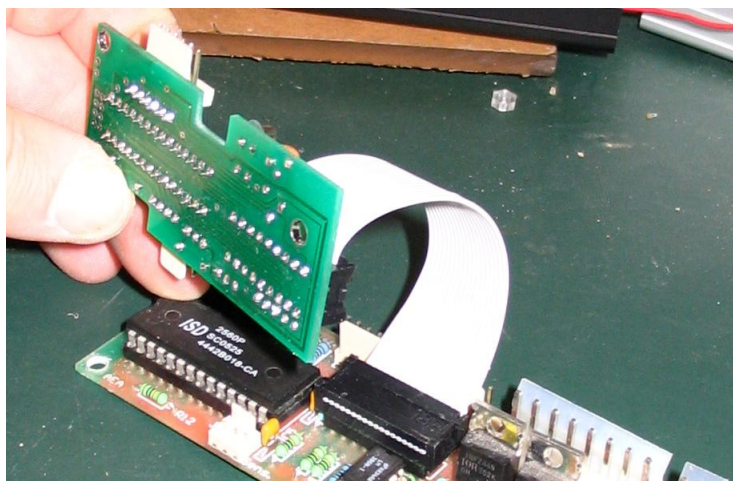

Figure 5. Rolling over the Proteus for the over-mount method



Figure 6. Proteus loose mounted in the over-mount position

The next step is to flip over the Proteus expansion board 360 degrees, rolling it down along the cable (refer Figure 5) such that it is facing upwards again, with its cable neatly wrapped over itself (refer Figure 6). It is now ready to mount to the BFS board.

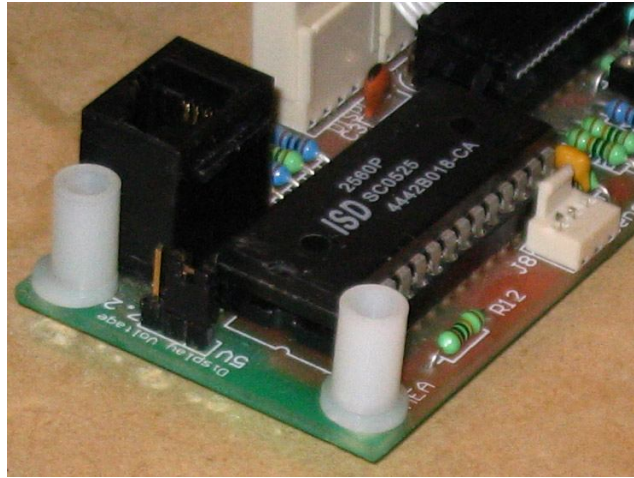

Figure 7. Spacers on the BFS board

Plastic spacers and washers are included to provide the necessary height clearance from the BFS board (only 2 of each are required in this method). Refer Figure 7, carefully fix the Proteus Expansion using the 2 leftmost mounting screws directly above the BFS board with the spacers sandwiched between the Proteus expansion and the BFS board (refer Figure 8).

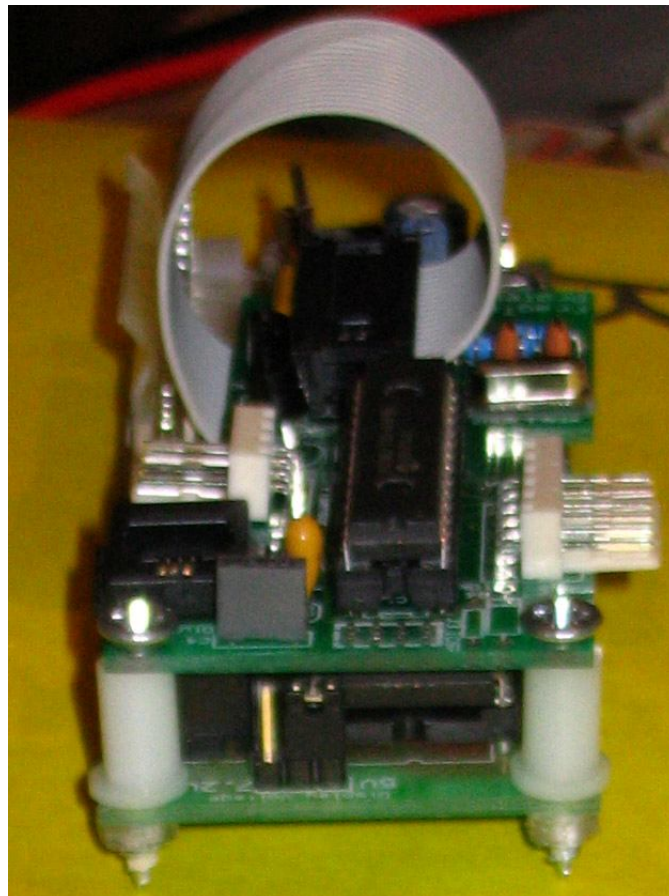

Figure 8. Proteus fixed in the over-mount position

Remote-Mount Method

The remote mount method provides the flexibility to mount the expansion board anywhere inside the tag gun casing (within the constraints of the lead length). This method may be required in casings where space is constrained around the BFS board itself. The Proteus connecting lead is attached in the same manner as shown in figure Figure 4. The polarity of the connection is very important; the lead is designed such that the connector lead extends upwards when connected to the BFS board. Care must be exercised when inserting the connector so as to prevent damaging the connector pins. It is recommended the operator is sufficiently 'earthed' to prevent static electricity from damaging the Proteus expansion board and the existing BFS board.

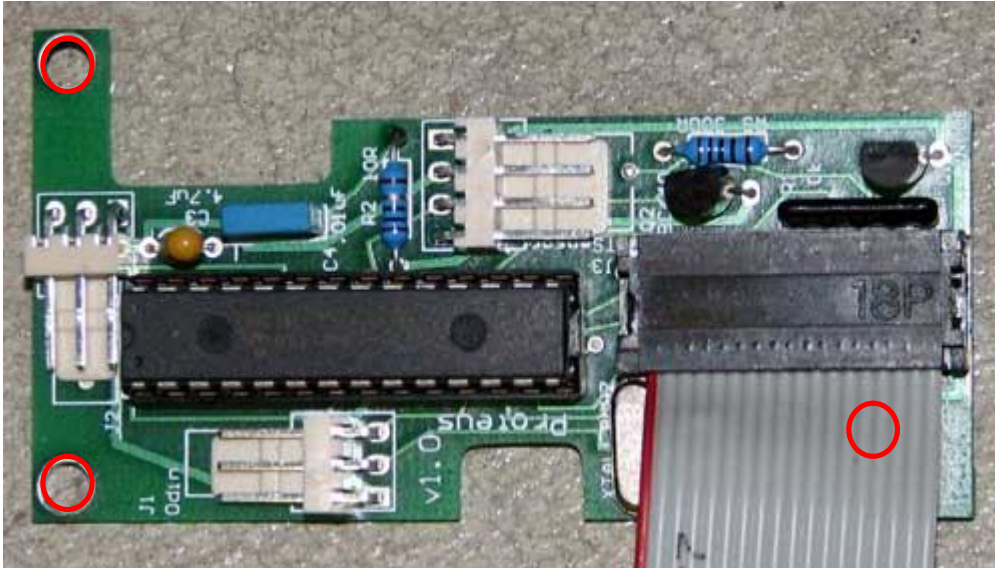

Figure 9. Proteus mounting holes (highlighted in red)

This mounting method requires the use of three hard points (refer Figure 9). In addition to the 2 holes on the left, the third hole (found under the connecting cable) is also utilised to provide the required stability for the Proteus expansion board.

Plastic spacers should be used to provide the necessary height clearance from the tag gun casing and prevent it from short circuiting. Carefully fix the Proteus Expansion using the all 3 mounting points with the spacers sandwiched between the Proteus expansion and the tag gun casing.

J1 – Odin Communications Connector

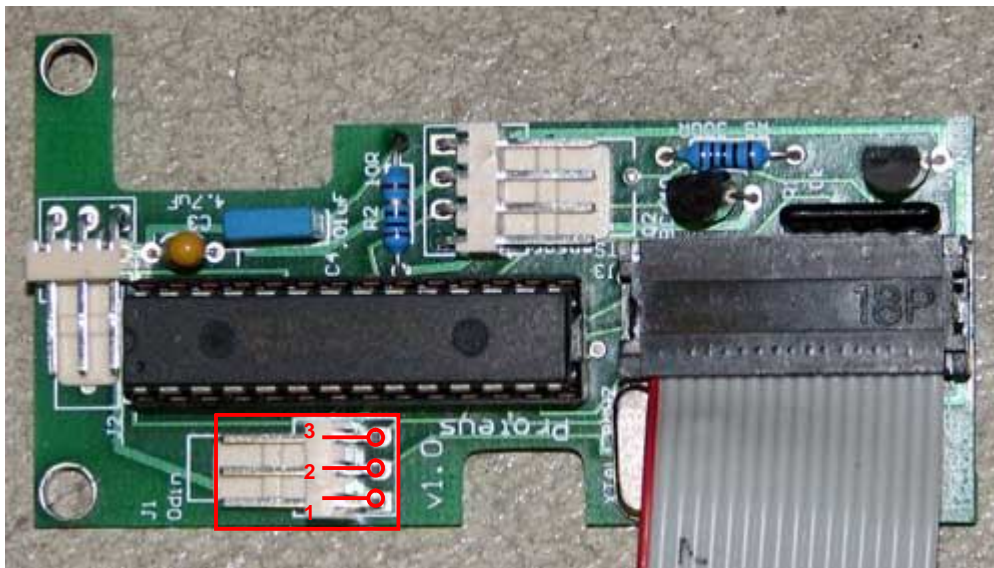

Figure 10. J1 – Odin Comms Connector

J1 (see Figure 10) requires a 3-way standard .100" polarised and locking header socket. Proteus can support communications to the FragTag Odin Master Controller. The pinouts for J1 from bottom to top are as follows:

- 1 - Ground
- 2 – Tagger Comms Clock
- 3 - Tagger Comms Data

Odin Master Controller Connections

If the optional Odin Master Controller is also being used with the Mainboard (for Odin data uploading), a 3.5mm stereo audio socket is required to be mounted on the gun.



Figure 11. Typical 3.5mm stereo audio socket

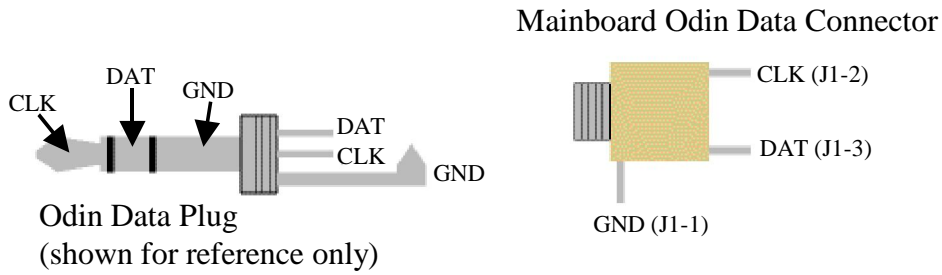

Figure 12. Odin Data Connector Pinouts

J2 – Expansion Connector

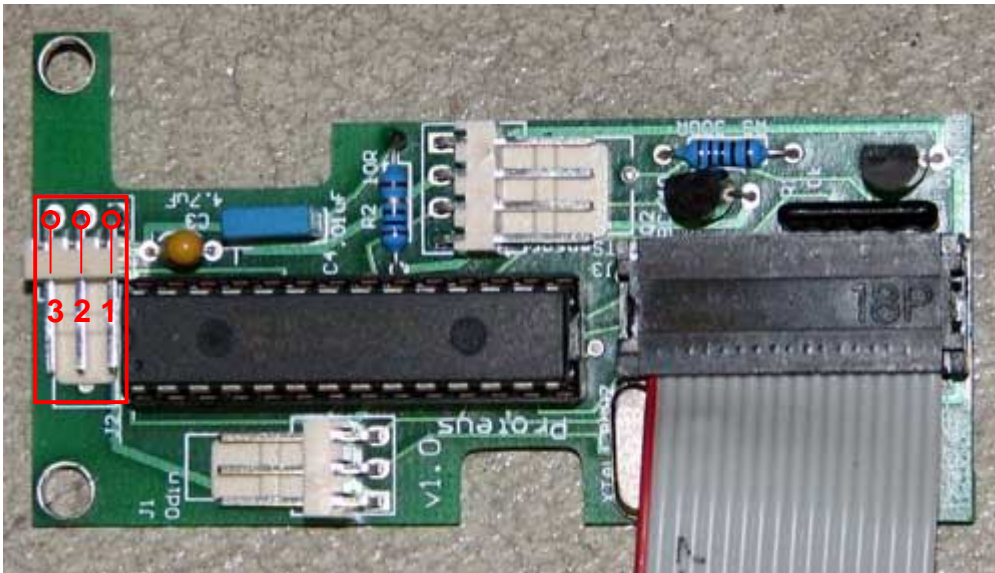

Figure 13. Expansion Connector Pinouts

Connector J2 (see Figure 14) allows for system expansion. This connector can be used to connect the Dallas iButton membership system.

The pinouts for J2 from right to left are as follows:

- 1 - +5v
- 2 – Membership button
- 3 - Reserved for future expansion

Dallas Membership Button connections

The optional membership button system allows players to be allocated with small disc-shaped “buttons” that contain a globally unique large number. The button can be “swiped” on the gun (held briefly against an external port) which can then be used to identify the player when the score data arrives back in the FragScore PC scoring application. This can then automatically print the player’s name and details on their score sheet, and keep track of their data over multiple games.



Figure 14. Membership button (bottom) and reader port (top)

Figure Figure 14 shows the required wiring for the membership port. The 4.7k ohm resistor must be mounted externally to the board, in the wiring loom.

Membership Port

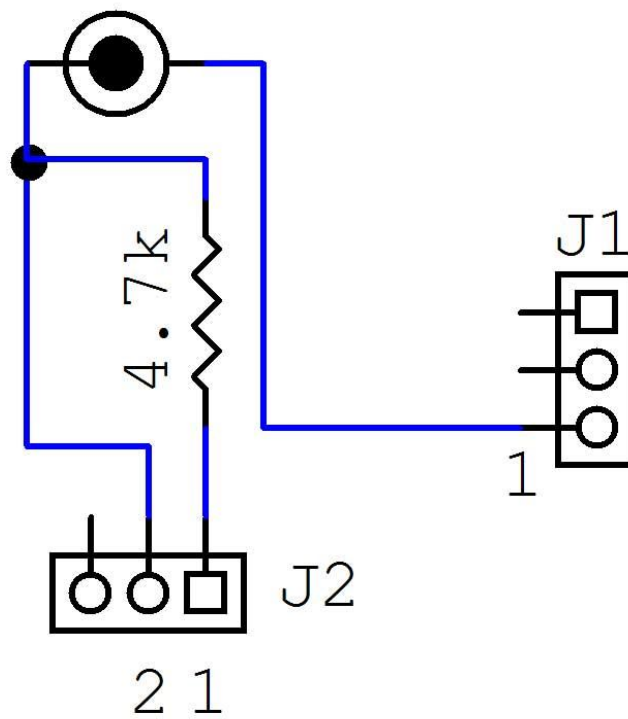

Figure 15. Membership button port wiring

J3 - FragTag Sensor Connector

J3 (refer Figure 16) requires a 4-way standard .100" polarised and locking header socket. Note: This is an optional feature; existing BFS sensors can be connected as normal (directly to the BFS board). Please note the BFS 'super-sensor' is supported however it must be used in conjunction with the BFS sensor interface board. Failure to use this interface board on a Super Sensor will result in malfunction.

This connection is provided as an optional upgrade for operators wishing to take advantage of the advanced FragTag Sensor (see our website for details on this accessory). The board can support any number of sensors (connected in parallel). The minimum required is 1, but 2 is recommended (1 front and 1 back). The pinouts for J3 from top to bottom are:

- 1- Vdd
- 2- GND (Vss)
- 3- Data
- 4- Hit LED +5v

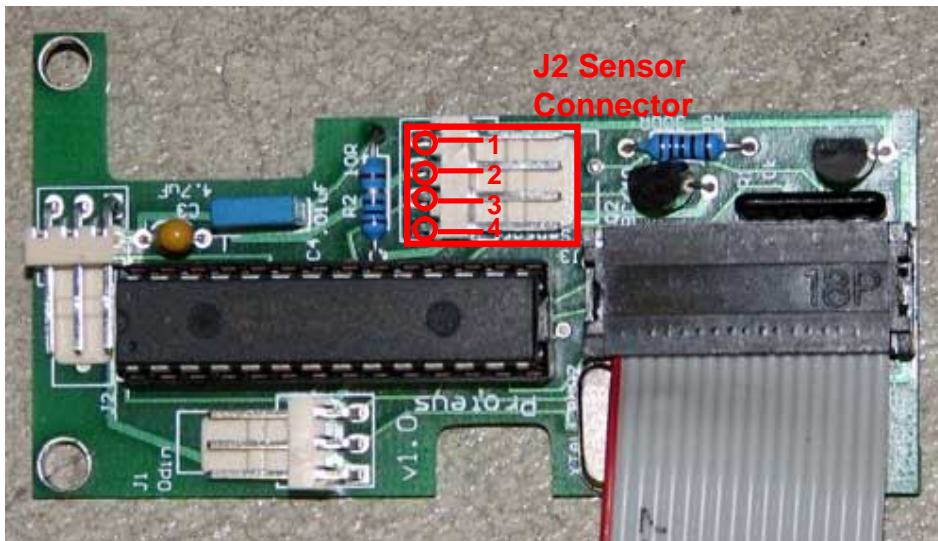

Figure 16. J3 Sensor Connector

Connection between J3 and a standard FragTag sensor requires an adaptor cable, detailed in Figure 17.

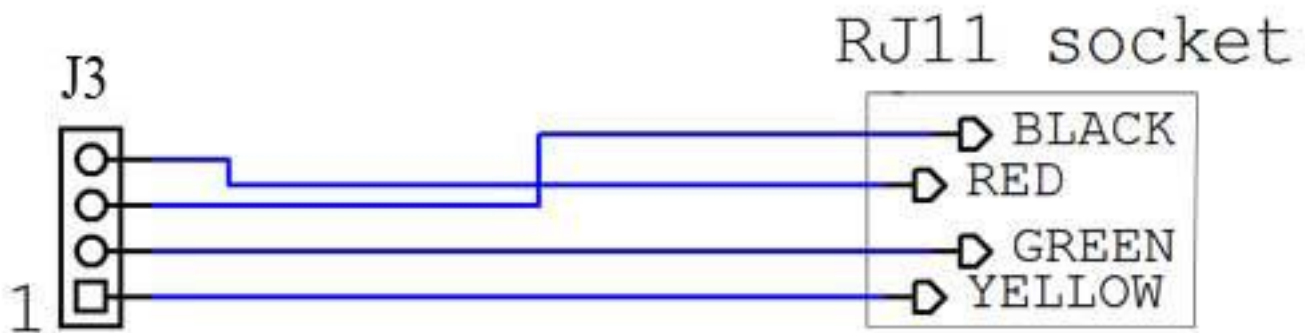

Figure 177. Sensor adaptor cable

Software Users Guide

This section describes the operation of the mainboard software.

Version Number

When the board is first switched on, it will display the software version that is running, for example version 2.50 would show as:



Configuration Data

Configuration data refers to the values and settings that control the operation of the gun.

The configuration data parameters are stored in such a manner that they are not cleared when the power is turned off, so the system will remember the last used configuration automatically.

During Powering on, the display will show as:



Upon pulling the trigger, the configuration menus will be entered.

Configuration Menus

In all configuration menus, the following buttons and functions apply:

Button	Function
Trigger	Enter Button: Accept current value and advance to next item
Primary Reload	Down Button: Move down through allowed values for current item
Primary Fire Mode	Up Button: Move up through allowed values for current item

Game Style



This menu allows the setting of the style of game play.

Game Style	Description
Arcade	Suited to younger or less experienced players. In this mode, you can only be hit once every 3 seconds. You will typically be given lots of ammunition.
Realistic	Suited to military simulations, this mode allows you to be hit once every 0.25 seconds (in FragTag protocol mode), or 1 second (in Wow mode.) You will typically be given more realistic (smaller) amounts of ammunition to more closely simulate real-world clip sizes.

Each press of the Up/Down buttons steps to the next style.

Health



This menu allows the setting of the player's initial health. Each press of the Up/Down buttons steps in 10 points. Minimum allowed value is 10, maximum is 100.

Clips



This menu allows the setting of the player's initial number of ammo clips. Each press of the Up/Down buttons steps in 1 clip. Minimum allowed value is 1, maximum is determined by the weapon configuration, which is set when the software is compiled (not user changeable.)

Sound Set



This menu allows the setting of the style of fire sounds that would like to use. The actual sounds used can be customised by the user when recording sounds.

Sound Set	Description
Sound1 (primary)	This sound set is typically used for the standard set of gun sounds.
Sound2 (secondary)	This set is typically used for silenced gun sounds.

Each press of the Up/Down buttons steps to the next set.

Signal Format



This menu allows the setting of the signal format to use. Each press of the Up/Down buttons steps to the next available signal format. Currently the supported formats are Worlds or Wonder/BFS (abbreviated as BFS) and MilesTag (abbreviated as Frg).

Team



This menu allows the setting of the player's team, for MilesTag mode. Each press of the Up/Down buttons steps to the next available team colour, from the following list:

Display (3 character abbreviation)	Team
RED	Red
BLU	Blue
YEL	Yellow

Note that this menu is skipped if you select Wow (BFS) mode.

Player ID



This menu allows the setting of the player's ID number. Each press of the Up/Down buttons steps to the next ID, between 0 and 31.

Warning: When playing in MilesTag mode, each player must be assigned a unique Team and Player ID. If any player's have duplicate settings, they will not be able to hit each other due to the self-hit prevention feature.

Note that this menu is skipped if you select Wow (BFS) mode.

Team and Player IDs are not relevant when using WOW mode.

Confirming Settings

At the completion of the configuration menus, you will be asked to confirm them. Pressing Fire will accept the settings, or pressing Reload or Fire Mode will go back to the start of the menus and allow you to correct any needed values.



Loading Default Configuration

If for some reason you wish to restore the default configuration, this can be achieved by switching off the power, pressing and holding the primary reload button, and switching on the power. When you see the message like this:



Release the button. Once this procedure has been performed, the configuration parameters are restored to the default values.

This procedure will happen automatically if the system detects that the configuration is invalid, which happens when the system's CPU is first programmed.

After performing this procedure, you will be taken to the Advanced Configuration menus that allow for low level settings that would not normally need to be changed frequently.

Advanced Configuration Menus

Setting the BFS Casing Style

The first menu to be shown after resetting to the default parameters (above) is the Casing Style menu.

BFS guns have two general styles; those with secondary fire (scatter gun), and those without secondary fire.

The Proteus module needs to be aware of which of these two it is being used in, so that it can correctly interpret the button inputs.

You will be shown a display with "SEC." on it (short for Secondary) followed by a number, 1 or 0. If your BFS gun has a secondary fire function, set this value to 1. If it does not, set it to 0. Refer to the table below for further details.

Press the Fire button to accept the shown setting. Press any other button to change the setting.



BFS Model	Secondary Fire Fitted	Value for Casing Style
M16 A2/M203	No	0
Morita Sniper/LMG	?	?
M4 M203 Carbine	No	0
Commando	No	0
Moriate SAW	?	?
Pulse Rifle	?	?
Spitfire	No	0
Scorpion	No	0

Caution: This setting is very important for the correct operation of Proteus.

If it is set incorrectly, the following behaviour will be observed:

- ❖ You will not be able to change the Fire Mode
- ❖ In the Configuration menus, you will not be able to change values in the Upwards direction (ie you can not change a weapon index from 3 to 4, but you can change it from 3 to 2.)

If you experience the above symptoms, perform the Loading Default Configuration procedure above, and then change the SEC value.

This setting does not have any influence on the ability to set a Secondary weapon in the following Weapon menus.

Note: The default value set during manufacture is 0, so be sure to change this if you are fitting to a gun with a secondary.

Setting the Sound Order

Firmware version 2.18 and above have the option of using a FragTag sound chip recording, or a BFS sound chip recording. The Sound Order menu allows the selection between these two options.

In this manner, you have the choice of keeping your existing BFS sound chip, or replacing it with a FragTag sound chip.



Value	Meaning
0	Use FragTag sound ordering (default)
1	Use BFS sound ordering

Note that using the BFS sound order is a compromise, as the BFS sound chip does not contain suitable sounds for all advanced FragTag events (eg near miss, game start etc.) We have attempted to select the nearest sound, however the overall success of this will need to be judged by the customer.

We would recommend that using the FragTag sound order and matching sound chip will provide the best results.

Setting the Weapon Types

The Weapon Library is a built in collection of guns that can be selected independently for both primary and secondary. That is, you could select for example a sub machine gun for your main (primary) weapon, and a pistol as your backup (secondary) weapon.

The weapons in the library will depend on what type of software you are running. The FragTag mainboard software is available in two types; "player carried" containing weapons for normal players to use, and "emplaced weapons" that are larger and more powerful, intended for fixed installations.

Refer to this document for a full listing of the available weapons (for mainboard version 2.50)

http://www.fragtag.com.au/downloads/FragTag_weapon_library_v1.0.pdf

* **Note:** the use of high fire rate weapons on a BFS board may result in premature wear of the infrared LED, due to the IR current resistor value fitted to the BFS mainboard. This may be increased, or a second resistor fitted in series with the LED to reduce the current and increase the LED life (this may result in some range loss.)

To select a weapon, use the Primary reload and Fire Mode buttons to move up or down through the list and set the index to one of the above values, and pull the trigger to accept.

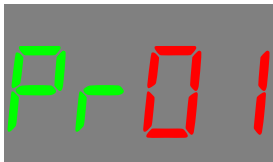

Note that some Primary Weapons cannot be used in conjunction with a Secondary Weapon. At the time of writing the Heavy Machine Gun and the M134 cannot be used with a Secondary Weapon, as the Secondary output is used to increase the primary fire rate.

Setting the Membership enable

After the weapon parameters have been selected, you will be given the option to enable the Dallas ID membership system. If you wish to use the membership system, and you have fitted the port and resistor as detailed in the hardware section, then use the Primary reload and Fire Mode buttons to select 1 and then Fire to accept.

Otherwise, select 0.

Important Note: setting this to 1 without having the resistor/port fitted will result in system malfunction!



Setting this value incorrectly will result in an alarm sound being heard over and over again.

Enabling Safety Fire Mode

For enhanced realism, guns can utilise a Safety fire mode, where the gun can be placed into a Safety mode and cannot fire. This may not suit all player types, hence this feature can be enabled or disabled. Use the Primary reload and Fire Mode buttons to select 1 (to enable it) or 0 (to disable) and then Fire to accept.



PLAY MODE

At the completion of the boot up stage, the system is ready to begin playing. The display will change to the main screen.

Main Screen

The main screen shows a summary of the current player status:

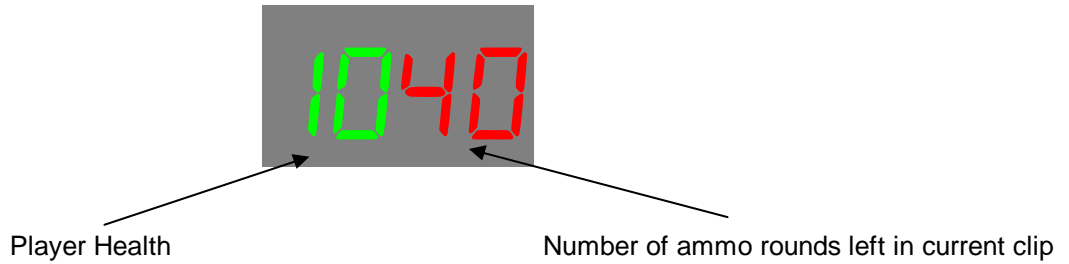

When this screen is active, pulling the trigger will begin to shoot rounds. The number of rounds fired depends on what *Fire Mode* you have selected.

- ❖ The "HEALTH" value shows the amount of health the player has left. The FragTag system uses health in a similar manner to a PC game; 100 health is the normal full value, and 0 health is dead. This is done due to the variable damage system; the more commonly used laser tag concept of "lives" is not suitable for variable damage systems as we take away a different amount of health for each gun (which gives far more realism.) Due to the limitations of the LED display, this value is shown divided by 10 i.e. 100 health shows as "10", 50 health shows as "05". Values from 1 to 9 are shown as "00"
- ❖ The Rounds value shows the amount of rounds (or virtual bullets) remaining in the current clip (or magazine) When this gets to zero, you can no longer fire and need to Reload. This value will automatically change to show the Primary or Secondary weapon value, as either is fired.

Fire Modes

The available Fire Modes depends on the weapon type that you have selected in the Weapon Selection Menu.

Mode	Description
Safety	Shots cannot be fired when the Safety is on. Display will show "SAFE" if you attempt to fire with the safety on.
Full Automatic	Shots are fired continuously for as long as the trigger is held down (and the clip has ammo.) Typically used on machine guns and assault rifles.
Burst Fire	For each trigger pull, a burst of multiple rounds is fired. The number of rounds in a burst is part of the weapon configuration. Only one burst will be fired for each press of the trigger. Typically used on sub machine guns.
Single Shot	One single shot is fired for each press and release of the trigger. Holding the trigger down will produce only one shot. This is typically used on Sniper Rifles.

Each available Fire Mode can be cycled through by pressing the Primary Fire Mode button. It will advance one mode for each button press and release.

Reloading

Once you have fired all of the rounds in the current clip, the main screen will change to show that your clip is empty:



At this time, pulling the trigger will play a sound to indicate you have no ammo left. When this occurs, it is necessary to press the Primary Reload button, to reload the gun with a new clip. Provided you have some primary clips left, the display will change to something like the following:



The right hand value is your health (as described above) while the left hand value is the number of ammo clips left (primary or secondary, depending on which you are reloading.) A time delay will occur, and when reloading is complete, and the display will change back to the normal main screen (a sound effect will be heard at this time too.)

The time taken to reload is set by the selected Weapon.

Once all clips have been used, the display will show "Out":

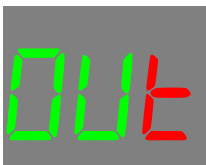

Secondary Weapons

If you have selected a Secondary Weapon in the weapon selection menu, you can fire this by pressing the "Secondary Fire" button. This will fire a round from the secondary weapon, and the main display will change the secondary Rounds.

Pressing the primary trigger button will change back to the primary weapon.

When the secondary weapon runs out of rounds, it will reload automatically (there is no secondary reload button.)

Taking Hits

If an opposing player hits you, your display will change to show "OUCH" and a sound effect will be heard.



If your Health is above zero, after a time delay (the delay depends on if you have set Arcade or Realistic modes) the display returns to the main display, and you can continue playing. When your health reaches zero, you are dead.

The Hit LED

When you are hit, the "Hit Led" on the sensor will flash quickly to alert other players that they have been successful in hitting you.

When you die, the Hit Led will stay on continuously for a time period of 4 minutes, and then it will automatically

During Respawning delay, or start delay for a timed game (refer to Odin User Manual for more details about timed games) the Hit Led will flash slowly.

switch off to conserve battery power.

Dieing

When your last amount of health is used, the screen will change to show "DEAD" and a sound effect is played.



At this point you are out of the game.

Respawning

When you are dead, you can be bought back to life (respawned) by a FragTag Master Controller or Utility Box device, or by using the power key to switch the power off and then on again. When this happens from a controller or box, the display will change to show a countdown until you can rejoin the game.

This countdown value is set to 10 seconds by default, but can be changed from the Master Controller device.

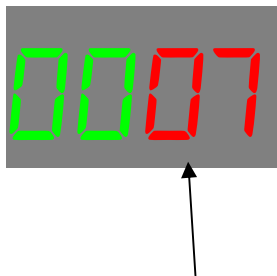

Time until respawn in seconds

Screen Saver

After a period of inactivity, the display will go into a power-saving screen saver mode. During this time a small “dash” symbol will flash slowly. Pressing any button or taking a hit will wake up the display. .



ADVANCED TOPICS

Near Miss

If your gun receives a hit signal that is not quite fully intact (for example, you may have just got the end of a signal, or a reflection) then you may experience a “near miss.” A sound effect will be played (a ricochet) and your firing may pause briefly. You will not take any damage from this, and it serves as a warning that you are under fire and should seek cover immediately.

Target

A special “weapon type” that can be set in the Weapons Library is a Target (refer to the configuration section for details.)

The Target mode can be used for simple target practice, range testing, sensor/gun testing, or scope calibration.

In this mode, you will not be able to fire. Hits will be taken from any player ID (including from the same player ID as the Target itself i.e. self hits are not prevented) but no damage will be taken (i.e. the Target cannot be killed and doesn't need to be respawned.)

Timed Games and Remote Configuration

The board allows full remote configuration and remote game control by using our Odin Master Controller. Refer to the Odin user manual for full details.

When playing timed games, the main display may change to a number of different screens depending on what is happening. Some examples:

Before a game starts, counting down (no firing or hits allowed during this time.)



Time until game starts, in seconds

Game Over, after the configured game duration has expired:



Membership Buttons

If the hardware has been fitted (refer to Hardware section) and you have enabled the Membership system (refer to configuration section) then a Membership button may be used.

The gun must have a reader port fitted in such a manner that it can be easily reached by the player, for example:



To use the Membership system, the player must touch and hold his ID button to the port for approximately 1 second. If the button is read correctly, a welcome sound effect is played.

If the button is not read correctly, an error alarm will sound.

If this occurs, hold the button against the port again. Be careful not to move it around for the time period. If you continue to have errors, ensure that both the button and the port are clean and free of any mud or dirt.

If problems persist on all buttons tried, you may need to check the internal wiring or replace the reader port.

Important Note: if the Membership system has not been enabled, the system will completely ignore any buttons held against the port. Refer to the configuration section for details of how to enable the Membership system.

Stuns

The system supports "Stuns" for example from a "Flash-bang" grenade. When this signal is received, you cannot fire for a time period. You can still take hits in this state.

Explosive and Radiation Damage

Certain FragTag products generate signals that simulate Explosive or Radiation damage (for example, Thor's Hammer time bomb.) These signals are accepted as per a normal gun hit.

Anti-Cheat Functions

Power Logging

The board software logs any occurrences of the power being switched off during a game, to detect cheating by players respawning themselves (a common problem for our competitor's systems.)

If this occurs on a FragTag system, the score data uploaded at the end of the game will be marked as having a power off event.

Sensor Failure

If a sensor fails (or is disconnected on a system that allows unpluggable sensors) then an alarm will sound and the system will cease to function until the problem is rectified.



In certain circumstances failure of a single wire within a connecting cable may cause the sensor to stop functioning yet not be detected. This is a limitation of the sensor modules and cannot be changed, however this would be a very rare occurrence.

Note that if Gun Sensors are used, the system can no longer detect if the Head sensor is fitted. We only recommend using unpluggable sensors if a gun sensor is not used.

Field Code

Guns can be configured via the Odin Master Controller to accept Respawn, Healing and Ammo signals from certain authorised devices only, and reject signals from unauthorised devices. Refer to the Odin User Manual for more details.

Important note: If the gun plays the alarm warning four times and shows a message "Invalid Field Code", it received a signal that did not contain the correct Field Code. In this case, use Odin to configure the Gun and/or Utility Box and/or Odin to the correct setting that is consistent in all devices that need to be used together.

Error Codes

Various system events can trigger an Error to occur. In this case, an error message will shown of the form:



The 2 digit number on the left is an error code, refer to following table.

Error Code	Cause	Resolution
00	Wrong Build type for remote setting of player weapon. Ie trying to set an Emplaced weapon type in a Player Carried build	Use the correct Build type in Odin, Emplaced or Player Carried, to suit the gun
01	Invalid Primary weapon index. Attempt to remotely configure the Primary weapon to an invalid setting.	Ensure the Odin version matches the Gun code version to ensure that all weapons in Odin are also in the Gun
02	Secondary weapon unavailable. Attempt to set a Secondary weapon type remotely when the Primary weapon type uses both IR channels.	Secondaries cannot be used if the Primary uses Alternating fire.
03	Invalid Secondary weapon index. Attempt to remotely configure the Secondary weapon to an invalid setting	Ensure the Odin version matches the Gun code version to ensure that all weapons in Odin are also in the Gun
04	Wrong Field Code. Gun received a Heal, Ammo or Respawn signal from a device with an incorrect Field Code	Set the Field Code correctly in Gun/Odin/Utility Box.

Data Logging and Scoring

The FragTag system has the outdoor tag industry's most comprehensive data logging and scoring system.

For every player (96 total supported) the following items are logged for each game:

- Hit Data (who you hit and who hit you)
- Shots Fired
- Total Damage inflicted
- Calculated Soldiering score (this is a value calculated from Damage inflicted, accuracy, respawns and heals)
- Number of times healed
- Number of times ammo was added
- Number of times the Administrator killed you
- Number of times respawned
- Health remaining at the end of the game
- Clips remaining
- Ammo remaining
- Primary damage value
- Secondary damage value
- Accuracy percentage
- Run Counter (number of minutes the gun has been switched on for)
- Rank among the other players in the game
- Membership ID code
- Bonus points awarded
- Explosive damage taken
- Radiation damage taken
- Number of stuns
- Detection for power cycling (cheating via key off, flat batteries etc.)

This data is uploaded from each gun at the end of a game using the FragTag Odin Master Controller. Odin collects all the data and can then pass it on to a PC, using the FragTag FragScore PC application.

FragScore displays all information and can print Score Cards for each player.

Sample display of FragScore, from a 24 hour game at Lazer Storm 2006:

FragScore 2 by FragTag

Games Missions Members Tools Settings Help

Team Rank

Rank	Team	Soldiering
1	Yellow	15090
2	Red	11625
3	Blue	3747

Active Mission: None

FRAGTAG

Player Rank

Rank	Player	Soldiering	Accuracy	Damage	Shots Fired	W.I.A.	K.I.A.	Ammo Adds
1	Yellow 3: Bingers	4357	11.52%	1464	1304	9	10	1
2	Red 1: Thorin	3070	20.17%	1059	898	49	1	21
3	Yellow 0: Callan	2330	6.30%	784	921	0	11	0
4	Yellow 1: Colin	2149	7.65%	728	863	5	11	4
5	Red 0: BJ	2134	7.54%	746	1025	56	2	11
6	Blue 3: Baatzbub	2089	5.16%	698	469	1	2	0
7	Yellow 10: Gimley	1940	10.20%	654	296	0	8	4
8	Red 4: Abacus	1928	6.52%	672	798	43	9	4
9	Red 7: Chipmonk	1863	10.88%	660	294	54	6	16
10	Red 5: 00	1512	6.84%	546	629	67	6	9
11	Yellow 8: Bunning	1104	8.06%	378	335	11	6	1
12	Yellow 5: Snake	1008	4.67%	350	535	11	12	1
13	Red 6: CS	809	1.85%	312	771	60	5	18
14	Yellow 2: Stone	807	9.37%	272	698	4	1	1
15	Blue 0: Pooh	710	2.26%	240	759	2	3	1
16	Yellow 4: Khidd	622	3.79%	214	509	0	10	0
17	Blue 2: Bully	590	8.10%	210	210	0	20	0
18	Yellow 7: 007	435	1.91%	154	787	6	7	3
19	Red 2: Witsy	422	3.96%	168	505	42	3	9
20	Blue 1: Owl	358	6.06%	120	99	0	1	0
21	Yellow 6: Angel	338	2.14%	120	187	2	9	1
22	Red 9: Pete	258	1.36%	90	220	0	6	0
23	Red 3: Piglet	-371	6.03%	-98	1145	35	2	14

Refer to the Odin and FragScore user manuals for further details of the scoring and data logging system.

Sample Soldier's Scorecard:



Greg Smith

HISTORY

TOTAL MISSIONS: 2

AVG. ACCURACY: 3.17%

AVG. DAMAGE: 252

AVG. SOLDIERING: 1758

SOLDIER

SCORECARD

FRAGTAG TEST FIELD

24/09/05 1:00PM

MISSION: Johnny on the spot	RANK	SOLDIERING
CLAN: None	1	1852
PLAYER ID: Red 1		

TOTAL DAMAGE	SHOTS FIRED	ACCURACY	W.I.A.	K.I.A.	AMMO ADDS
284	167	12.15%	0	0	0

PLAYERS THAT YOU HIT:

Blue 0: 112 (Robin Marston)

Blue 1: 112 (Ron Jones)

Blue 10: 60 (Aaron Sawyer)



PLAYERS THAT HIT YOU:

Blue 0: 70 (Robin Marston)

Blue 1: 14 (Ron Jones)

Blue 10: 20 (Aaron Sawyer)



www.fragtag.com.au

© FragTag 2008

Page 38 of 44

Upgrading the Firmware

The board has the ability to have its software updated by the owner, without opening the gun casing, in approximately 60 seconds per gun. In this manner you can maintain and upgrade your fleet yourself without the need for expensive or time consuming replacing of chips.

Items Needed

You will need the following items to perform this procedure:

- ❖ FragTag PC interface module. This module was previously available from our Store but has now been superseded by the USB interface module.

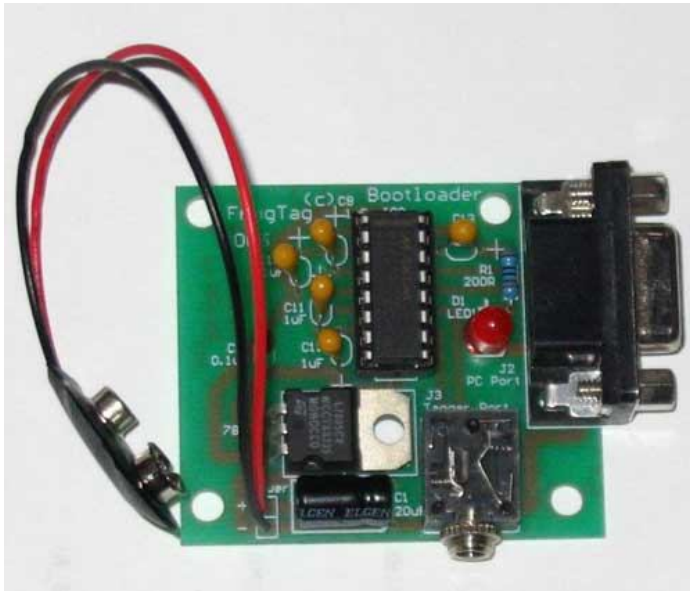

- ❖ Alternatively, a USB interface cable can be used, available from our Store at <http://www.fragtag.com.au/store.htm>
- ❖ A installed copy of FragScore, available from <http://www.fragtag.com.au/downloads.htm>
- ❖ If using the FragTag PC interface module, an Odin port cable – standard 3.5mm stereo audio jack. Available from many stockists, e.g. Jaycar Electronics WA-7007. This is not required if using the USB interface



module.

- ❖ If using the FragTag PC interface module , an Odin PC serial cable – female 9 pin D to male 9 pin D. This must be a straight through connection type, not a “cross over” type. For example, Jaycar electronics WC-7534 computer mouse extension cable. This is not required when using the USB interface module.



Procedure

Be sure to follow all steps carefully, or malfunction may result.

Step 1: Download the firmware file that you wish to update to, from <http://www.fragtag.com.au/downloads.htm>. This will be a small file with a “.ftg” extension on it, for example “mainboard_2.09.ftg”

Step 2: Switch off power to the gun. Connect the stereo audio lead from the gun to the PC interface module, and connect the serial cable to the PC interface module, and the other end to a spare communications port on your PC. If using the USB interface module, just plug it into the PC (ensure the drivers are installed first, available from the Downloads page of our web site.)

Switch on power to the PC interface module.

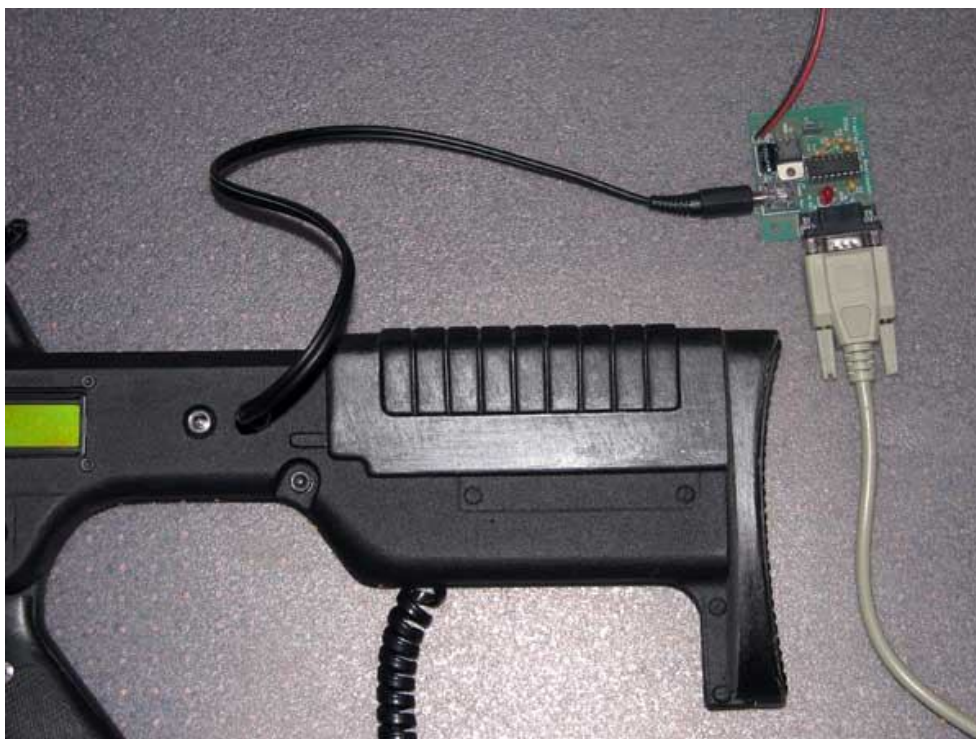

Communications ports on your PC generally look like the ones marked as “serial” in this picture:



communications ports

Step 3: Start the FragScore PC application, and select the “Settings” menu, and then “Communications Port”.

In the window that appears, select the relevant Comm Port, depending on which communications port you used in Step 2. Often these ports are not labelled on the PC, so it may take some guess work and trying of both settings to see which one works. Usually comm. 1 is the one on the right hand side of the above picture. When you have made your selection, press “Save and Exit.”

For the USB adaptor, the virtual Comm Port number be determined by viewing the Device Manager in the Windows Control Panel, under Ports.

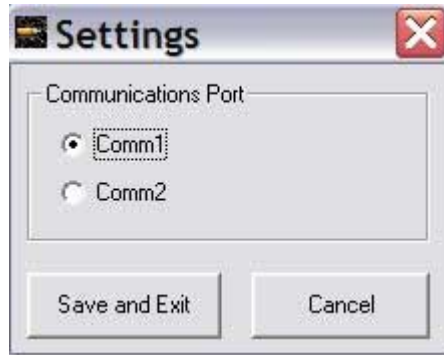

Step 4: Select the “Tools” menu, and then “Firmware Update”



Step 5: In the window that appears, select the “Open File” button, and browse to the firmware file downloaded in Step 1.



Step 6: Press the “Download” button.

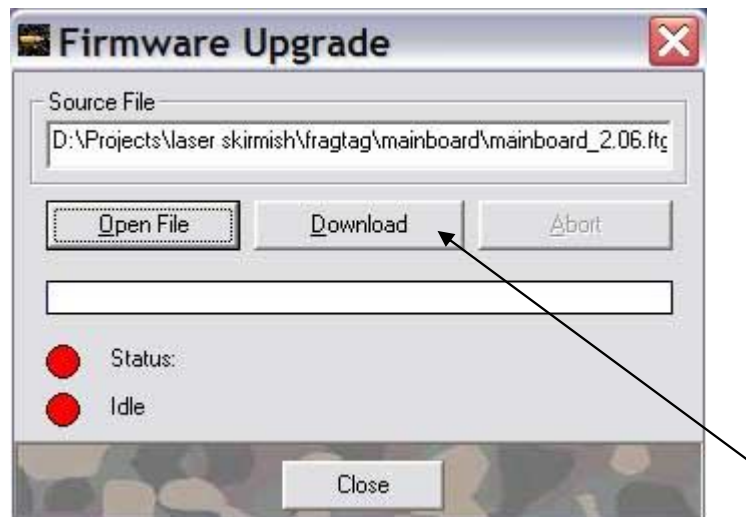

Step 7: Switch on the gun. After a short time, the FragScore display should show that it has connected, and the progress bar will begin to move across the screen. At this time, the gun display will be blank, and the hit led will be illuminated.

Step 8: After approximately 60 seconds, the progress bar will reach 100% and the gun will start up automatically, and you will be taken to the configuration menus (refer to configuration section.) Unplug the stereo audio cable from the gun.

This completes the update procedure. Additional guns can be updated by plugging in a new gun (with the gun power off) and repeating steps 6 to 8.

At the completion of all updates, exit from FragScore and unplug all cables (if desired) and ensure to switch of the PC interface module, to save its battery (if applicable.)

Troubleshooting

If the above procedure does not work, check these items:

- ❖ Try a different comm port number in the step 3. It can be difficult to identify which port is which on a PC
- ❖ Check the PC interface module battery and ensure it has at least 7 volts (preferably higher.) If in doubt, replace the battery.
- ❖ Double check all of your connections and cables, including the connection between the mainboard and the Odin port inside the gun (refer to Hardware section.)

If all of the above still fail to work, contact us on techsupport@fragtag.com.au